



=25°C (unless otherwise specified)

=25°C
=100°C

±

=25°C
=25°C

°C

°C/W

°C/W



=25°C (unless otherwise specified)

=±20V, V

=25°C

=100°C

±



--	--

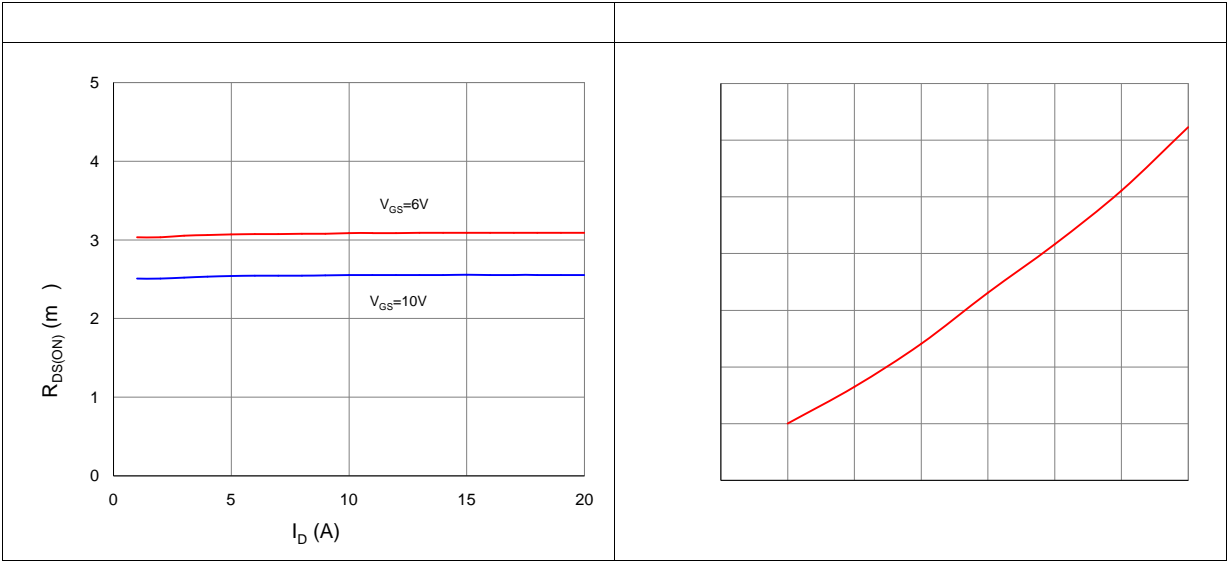

--	--

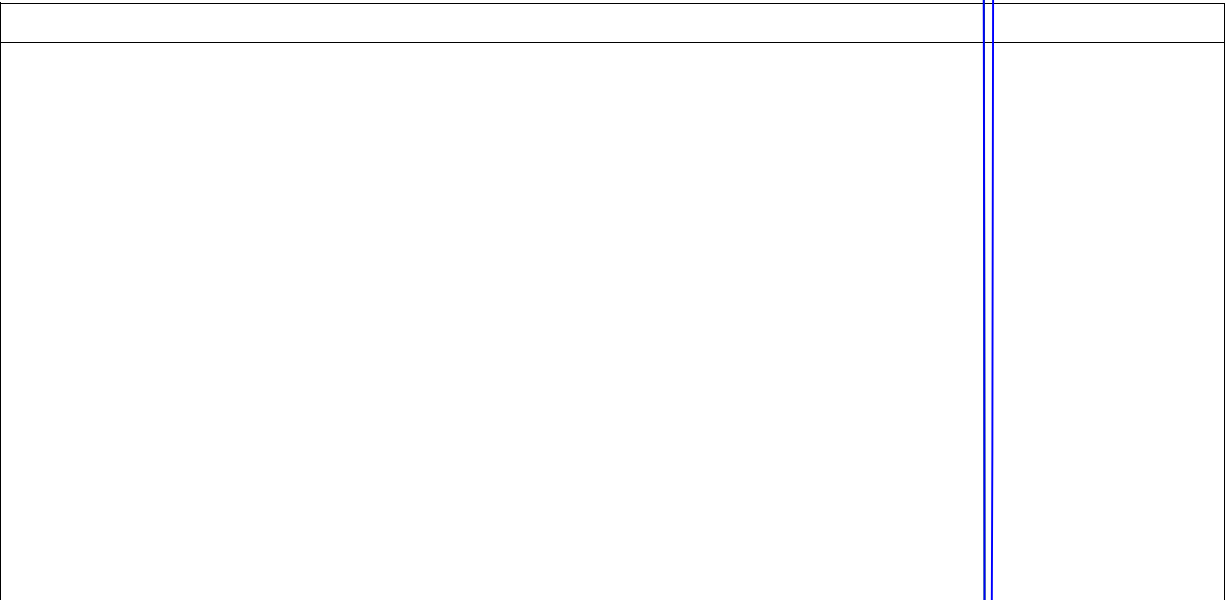
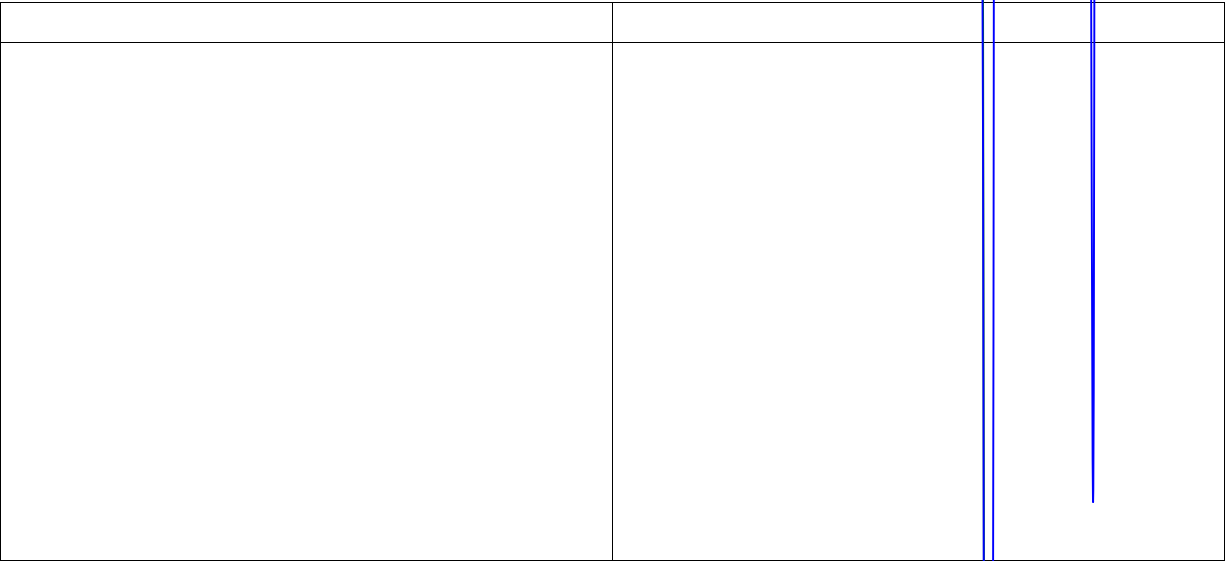
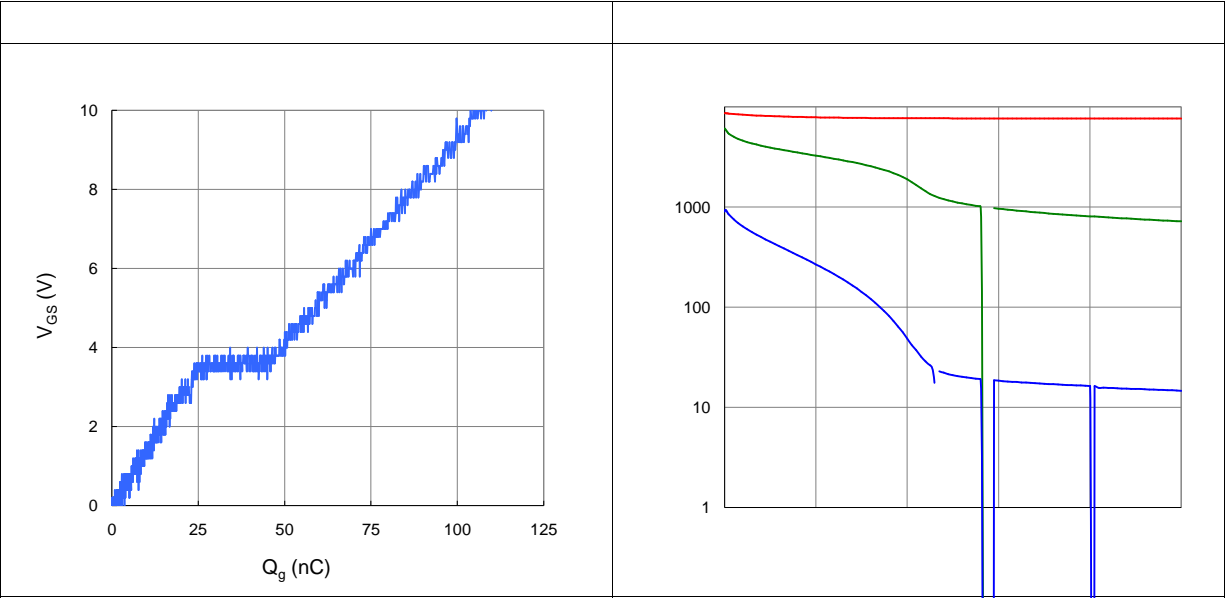

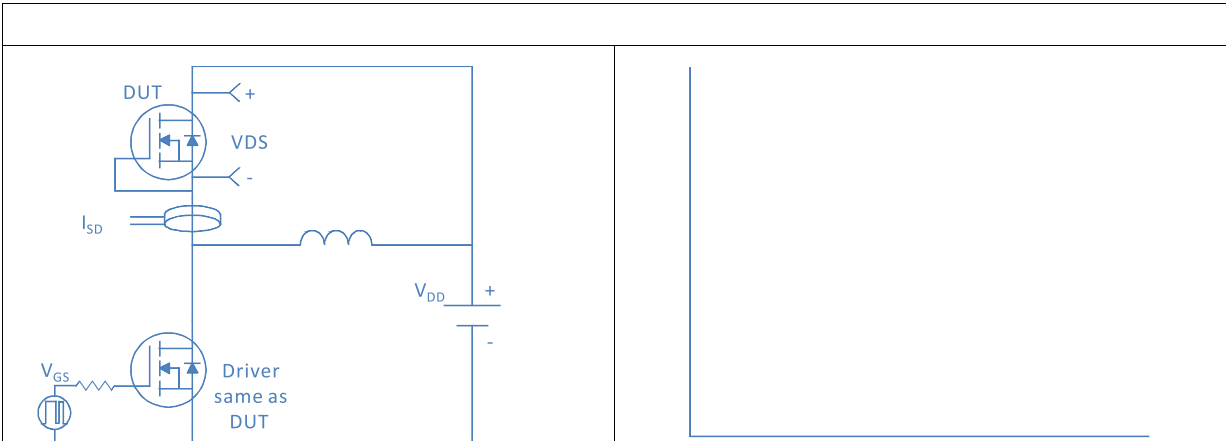
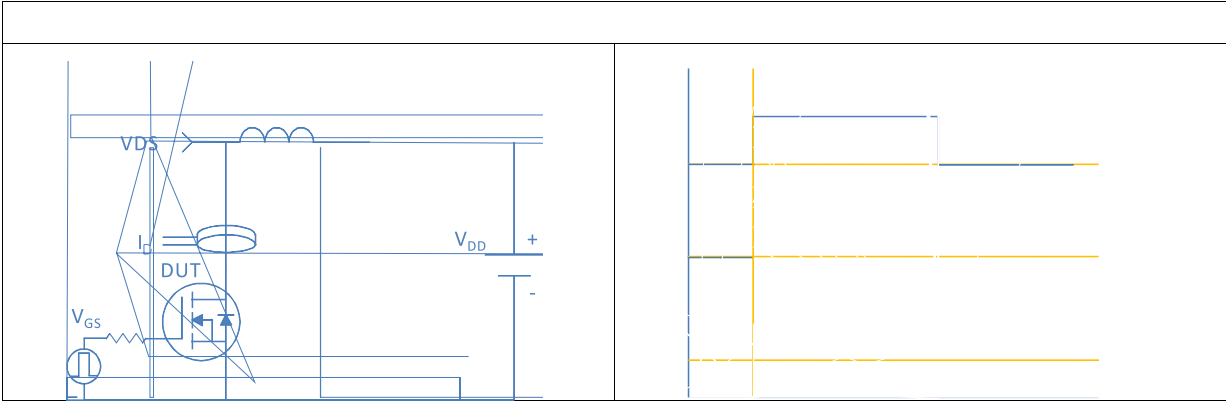
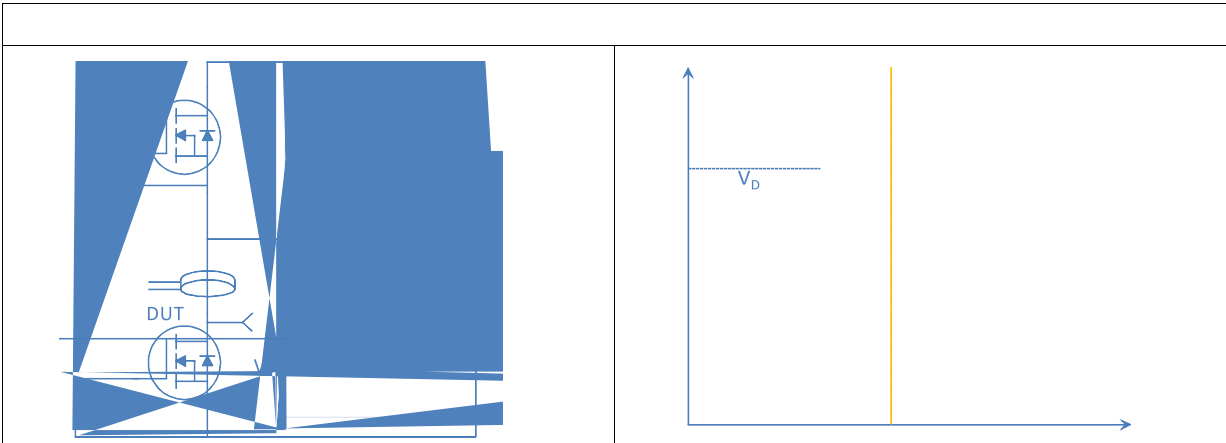
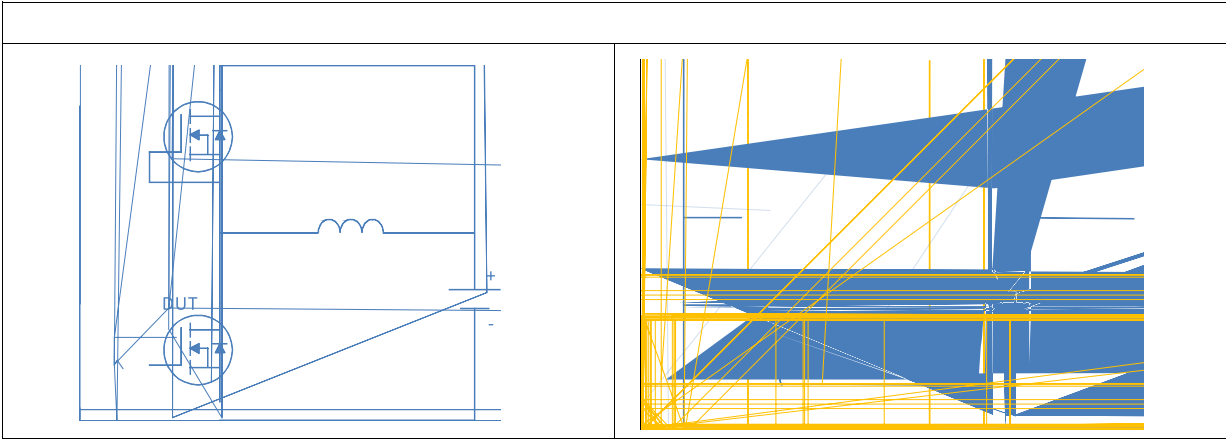

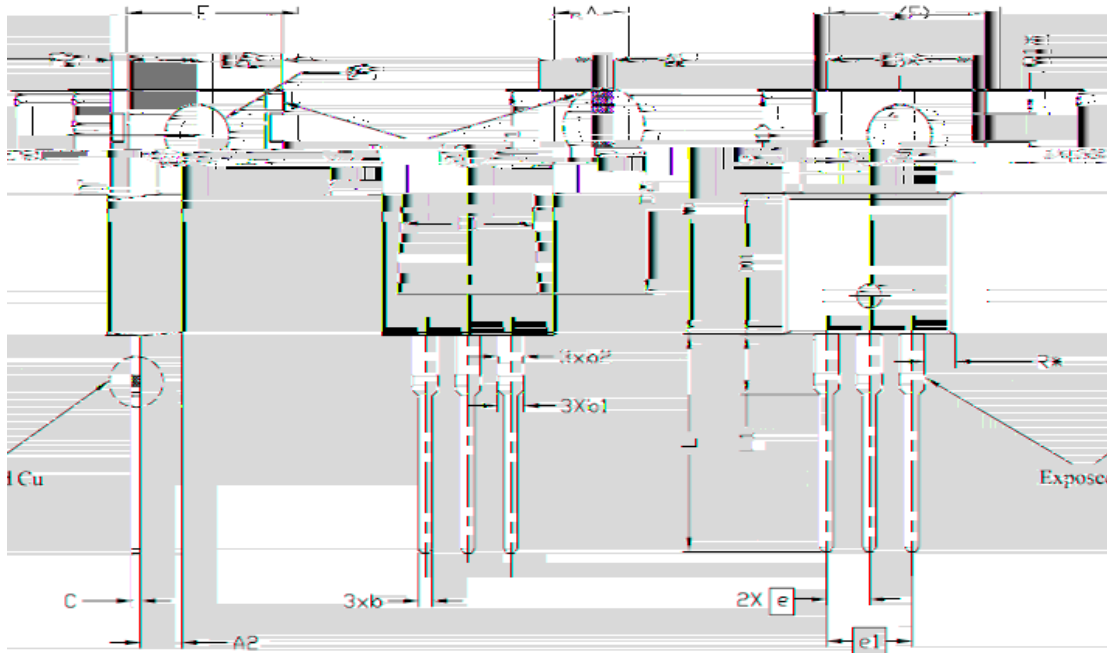

SYMBOL	DIMENSIONS			NOTES
	MIN.	NOM.	MAX.	
A	4,24	4,44	4,64	
A1	1,15	1,27	1,40	
A2	2,30	2,48	2,70	
b	0,70	0,80	0,90	
b1	1,20	1,55	1,75	
b2	1,20	1,45	1,70	
c	0,40	0,50	0,60	
D	14,70	15,37	16,00	4
D1	8,82	8,92	9,02	
D2	12,63	12,73	12,83	5
E	9,96	10,16	10,36	4,5
E1	6,86	7,77	8,89	5
E2	-	-	0,76	6
E3*	8,70REF.			
e	2,54BSC			
e1	5,08BSC			
H1	6,30	6,45	6,60	5,6
L	13,47	13,72	13,97	
L1	3,60	3,80	4,00	
øP	3,75	3,84	3,93	
Q	2,60	2,80	3,00	
Q1*	1,73REF.			
R*	1,82REF.			

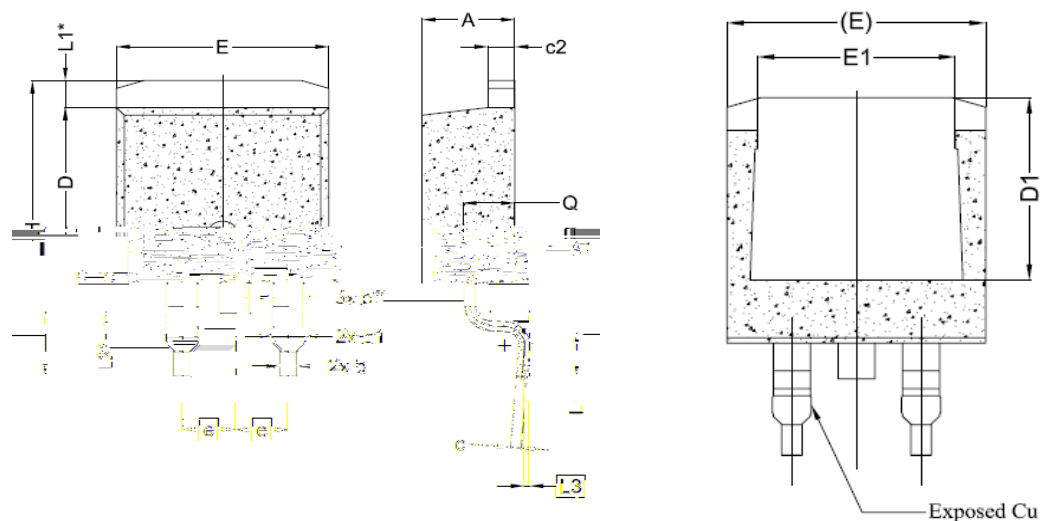

SYMBOL	DIMENSIONS		
	MIN.	NOM.	MAX.
A	4.24	4.44	4.64
A1	0.00	0.10	0.25
b	0.70	0.80	0.90
b1	1.20	1.55	1.75
b2	1.20	1.45	1.70
c	0.40	0.50	0.60
c2	1.15	1.27	1.40
D	8.82	8.92	9.02
D1	6.66	7.65	

E	8.82	10.16	
E1	6.88	7.62	
e		2.64	
H	14.51	15.20	
L	1.78	2.38	
L1		1.35 REF.	
L2		1.50 REF.	
L3		0.25 BSC	
Q	2.30	2.46	

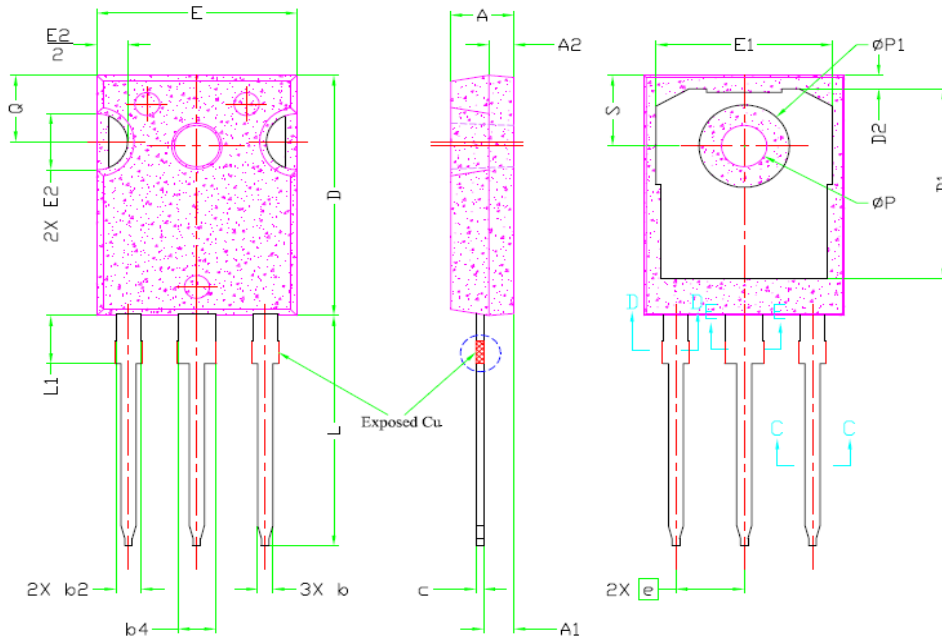

SYMBOL	DIMENSIONS			NOTES
	MIN.	NOM.	MAX.	
A	10.00	10.00	10.00	
A2	1.00	1.00	1.00	
E	14.00	14.00	14.00	
D	18.00	18.00	18.00	
E1	13.45	13.45	13.45	
S	4.82	4.82	4.82	
D1	18.25	18.25	18.25	
D2	16.51	16.51	16.51	
ØP	0.65	0.65	0.65	
ØP1	2.00	2.00	2.00	
L	10.41	10.41	10.41	
L1	1.00	1.00	1.00	
L2	1.00	1.00	1.00	
L3	1.00	1.00	1.00	
L4	1.00	1.00	1.00	
L5	1.00	1.00	1.00	
L6	1.00	1.00	1.00	
L7	1.00	1.00	1.00	
L8	1.00	1.00	1.00	
L9	1.00	1.00	1.00	
L10	1.00	1.00	1.00	
L11	1.00	1.00	1.00	
L12	1.00	1.00	1.00	
L13	1.00	1.00	1.00	
L14	1.00	1.00	1.00	
L15	1.00	1.00	1.00	
L16	1.00	1.00	1.00	
L17	1.00	1.00	1.00	
L18	1.00	1.00	1.00	
L19	1.00	1.00	1.00	
L20	1.00	1.00	1.00	
L21	1.00	1.00	1.00	
L22	1.00	1.00	1.00	
L23	1.00	1.00	1.00	
L24	1.00	1.00	1.00	
L25	1.00	1.00	1.00	
L26	1.00	1.00	1.00	
L27	1.00	1.00	1.00	
L28	1.00	1.00	1.00	
L29	1.00	1.00	1.00	
L30	1.00	1.00	1.00	
L31	1.00	1.00	1.00	
L32	1.00	1.00	1.00	
L33	1.00	1.00	1.00	
L34	1.00	1.00	1.00	
L35	1.00	1.00	1.00	
L36	1.00	1.00	1.00	
L37	1.00	1.00	1.00	
L38	1.00	1.00	1.00	
L39	1.00	1.00	1.00	
L40	1.00	1.00	1.00	
L41	1.00	1.00	1.00	
L42	1.00	1.00	1.00	
L43	1.00	1.00	1.00	
L44	1.00	1.00	1.00	
L45	1.00	1.00	1.00	
L46	1.00	1.00	1.00	
L47	1.00	1.00	1.00	
L48	1.00	1.00	1.00	
L49	1.00	1.00	1.00	
L50	1.00	1.00	1.00	
L51	1.00	1.00	1.00	
L52	1.00	1.00	1.00	
L53	1.00	1.00	1.00	
L54	1.00	1.00	1.00	
L55	1.00	1.00	1.00	
L56	1.00	1.00	1.00	
L57	1.00	1.00	1.00	
L58	1.00	1.00	1.00	
L59	1.00	1.00	1.00	
L60	1.00	1.00	1.00	
L61	1.00	1.00	1.00	
L62	1.00	1.00	1.00	
L63	1.00	1.00	1.00	
L64	1.00	1.00	1.00	
L65	1.00	1.00	1.00	
L66	1.00	1.00	1.00	
L67	1.00	1.00	1.00	
L68	1.00	1.00	1.00	
L69	1.00	1.00	1.00	
L70	1.00	1.00	1.00	
L71	1.00	1.00	1.00	
L72	1.00	1.00	1.00	
L73	1.00	1.00	1.00	
L74	1.00	1.00	1.00	
L75	1.00	1.00	1.00	
L76	1.00	1.00	1.00	
L77	1.00	1.00	1.00	
L78	1.00	1.00	1.00	
L79	1.00	1.00	1.00	
L80	1.00	1.00	1.00	
L81	1.00	1.00	1.00	
L82	1.00	1.00	1.00	
L83	1.00	1.00	1.00	
L84	1.00	1.00	1.00	
L85	1.00	1.00	1.00	
L86	1.00	1.00	1.00	
L87	1.00	1.00	1.00	
L88	1.00	1.00	1.00	
L89	1.00	1.00	1.00	
L90	1.00	1.00	1.00	
L91	1.00	1.00	1.00	
L92	1.00	1.00	1.00	
L93	1.00	1.00	1.00	
L94	1.00	1.00	1.00	
L95	1.00	1.00	1.00	
L96	1.00	1.00	1.00	
L97	1.00	1.00	1.00	
L98	1.00	1.00	1.00	
L99	1.00	1.00	1.00	
L100	1.00	1.00	1.00	